

ITEM	PART NO.	QTY	MODEL / DESCRIPTION
1	(3188/A)	1	USER MANUAL
2	(3189/A)	1	VBV-71XXC-8KIT CAMERA BRACKET
3	(3190/A)	1	VBV-71XXC-SS CAMERA SUNSHIELD
4	(3191)	1	VBV-71XXC-FIK CAMERA FILING PACK
5	(3347/A)	1	VBV-71XXC-IG INSTALLATION GUIDE (NOT SHOWN)

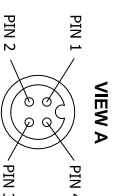
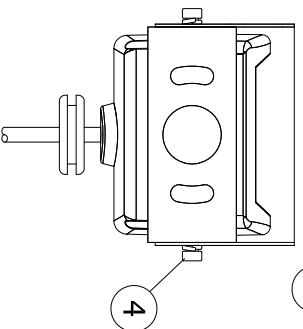
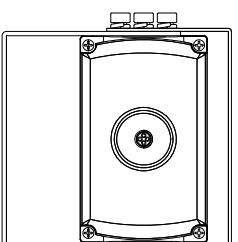
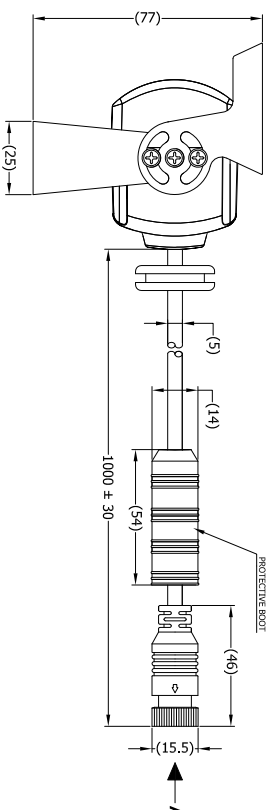
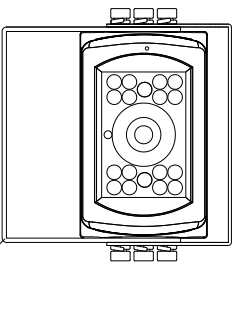
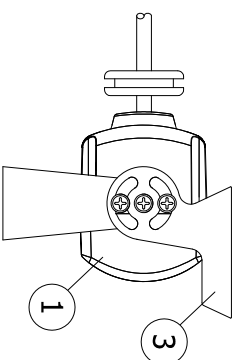

PIN #	WIRE COLOUR	DESCRIPTION
1	RED	12 VDC
2	BLACK	GROUND
3	WHITE	AUDIO
4	YELLOW	VIDEO

- NOTES:**
- REFER TO PRODUCT SPECIFICATION FOR PRODUCT SPECIFICATIONS.
 - REFER TO COMPONENT DRAWINGS FOR COMPONENT DETAILS
 - FOR GIFTBOX LABEL REFER TO LATEST REVISION OF DRAWING BE-002470-XX-13.
 - FOR GIFTBOX SERIAL NUMBER LABEL REFER TO REVISION OF DRAWING BE-001323-XX-10.
 - PURCHASE ORDER TO DEFINE PACKAGING VARIANT.
 - REFER TO LATEST REVISION OF DRAWING BE-001985-XX-12 FOR PACKAGING DETAIL.

PROPRIETARY NOTICE

THIS DESIGN AND TECHNICAL INFORMATION APPEARING ON THIS DRAWING IS THE PROPERTY OF BRIGADE ELECTRONICS, AND IS DISCLOSED IN CONFIDENCE. IT IS NOT TO BE COPIED, REPRODUCED, REVISED TO OR EXPROPRIATED BY OTHERS, EITHER IN WHOLE OR IN PART WITHOUT THE EXPRESS WRITTEN CONSENT OF BRIGADE ELECTRONICS.

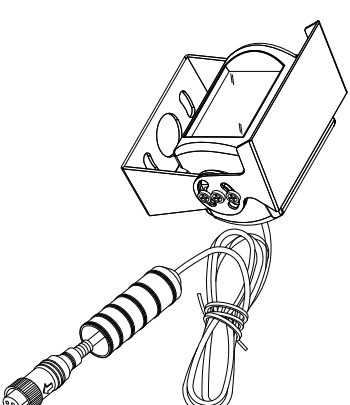

Assembly Pl Approval XINYU HUANG (17/06/13)	Approved by B. JOHN	Checked by B. CHILDS	Drawn by M. BUTLER
--	------------------------	-------------------------	-----------------------

Angle of Projection
Third Angle

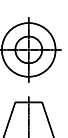

Third Angle

Status RELEASED	Units mm	Scale N/A	Released 18/06/13	Assembly Ref 12201002073
--------------------	-------------	--------------	----------------------	-----------------------------

VBV-700C

Part No
1379C

BRIGADE
 www.brigade-electronics.com